

Article number: 204250M12125A0S

Description: E+G levelling foot  
GN 42-50-M12-125-A0-S

Note: S Without nut, External hexagon at the bottom

## Measures

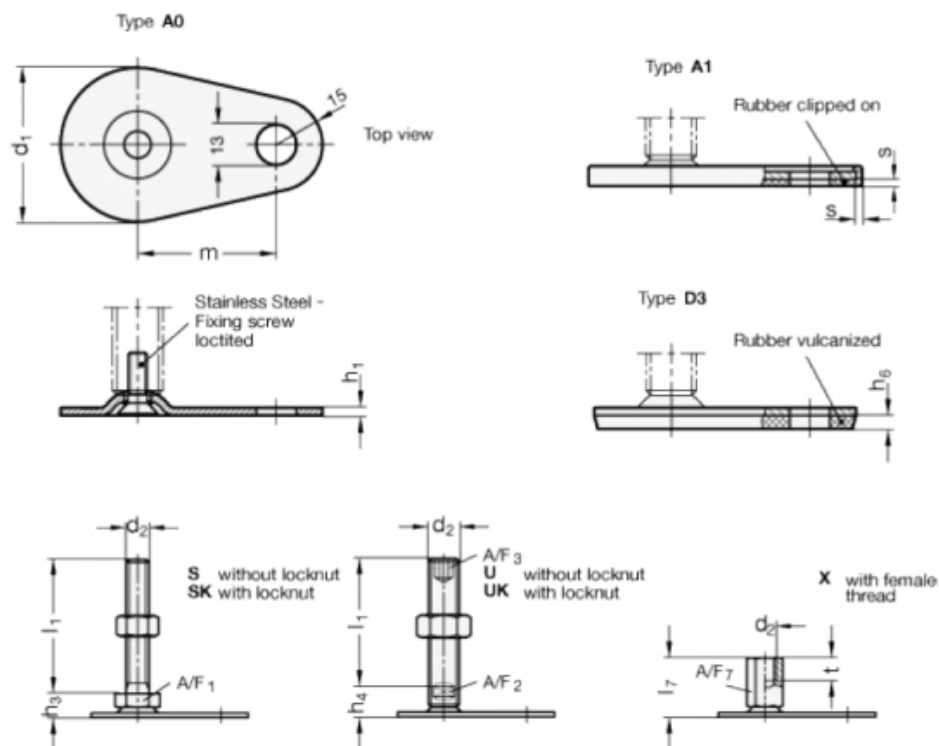

A/F1 = 17

d1 = 50

d2 = M12

h1 = 2.5

h3 = 11

h6 =

l1 = 125

m = 45

s =